

TECHNICAL DATA

Nominal heat output	6 kW
Efficiency	82 %
Smoke flue diameter	150 mm
Min. feed pressure at nominal heat output	12 Pa
Flue-gas temperature	262 °C
Volume flow of combustion products	4,6 g/s
CO emission in burnt gas (in relation to 13 % O ₂)	0,0873 %
Dust in flue - gas (in relation to 13 % O ₂)	19 mg/Nm ³
Fuel consumption per hour	1,85 kg/h
Fuel	wood (beech logs)
Weight	236 kg



LIST OF SPARE PARTS

Glass

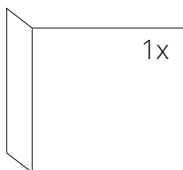

530 x 330 x 468 mm

Set of carcon firebox lining

1. Front bottom
2. Back bottom
3. Back
4. Side
5. Deflector
6. Cast iron grate
7. Ashtray

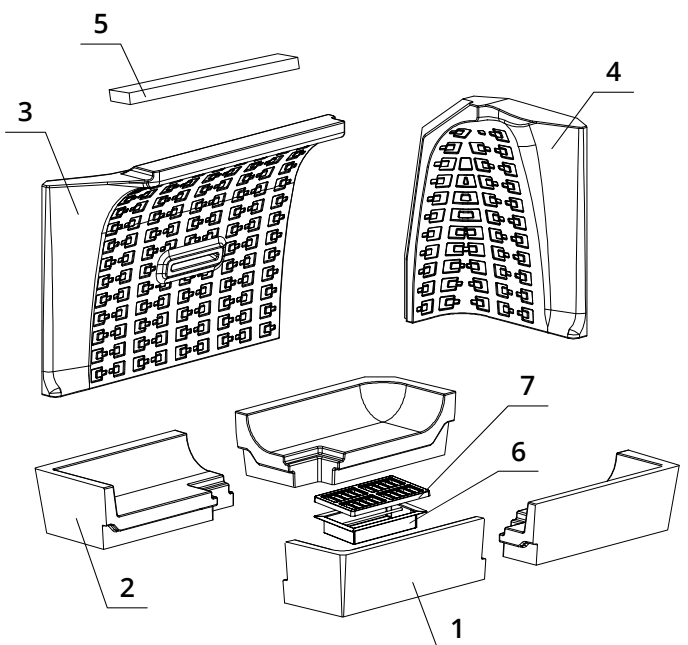

BEF THERM V 6 CL

BlmSchV
Stufe 2

15a
B - VG

ČSN EN
13229

TECHNICAL DRAWING

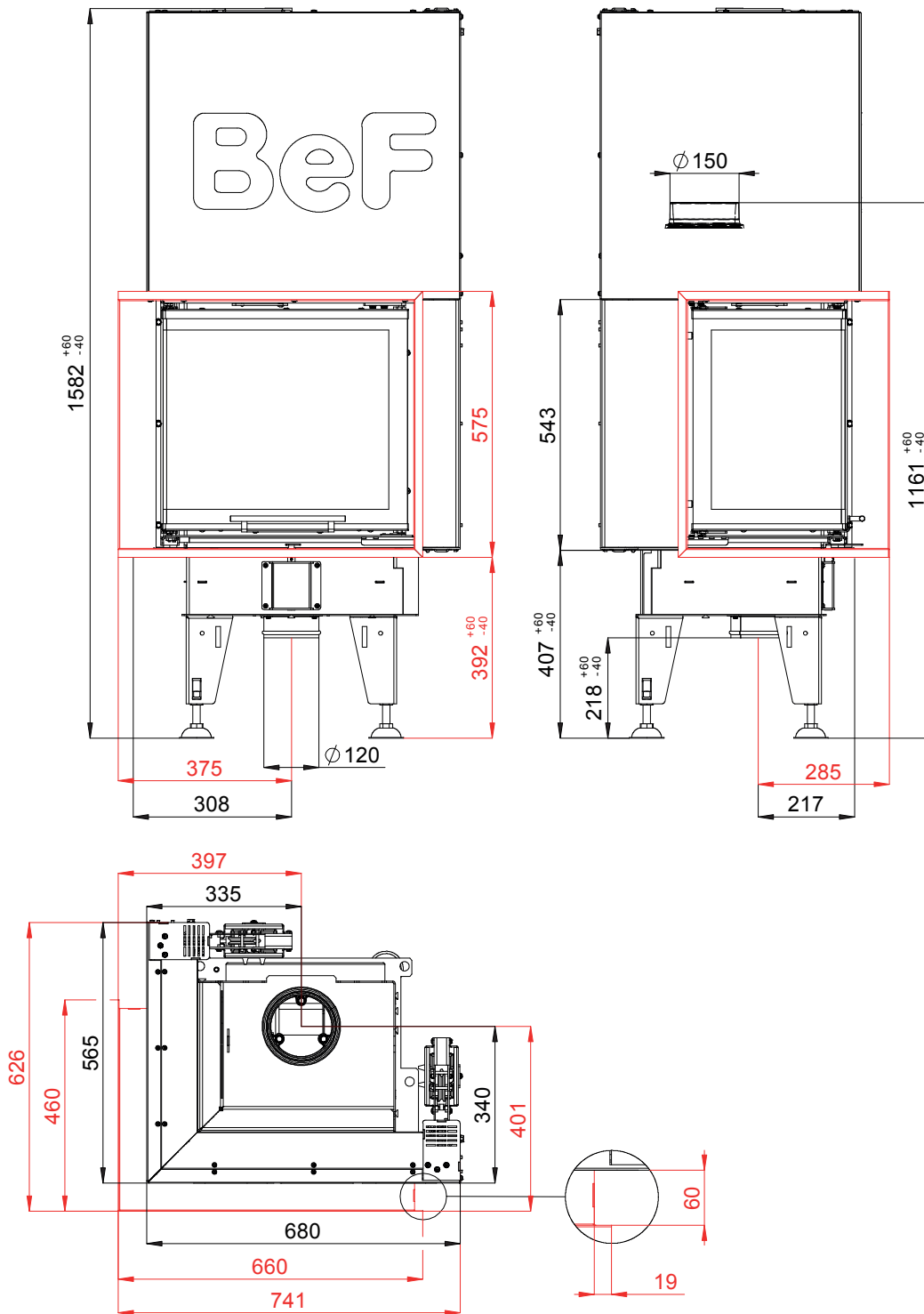

BEF THERM V 6 CL

BlmSchV Stufe 2	15a B-VG	ČSN EN 13229
--------------------	-------------	-----------------

www.befhome.com