

SPECIFICATIONS

Rated thermal input	7 kW
Efficiency	82 %
Smoke flue diameter	150 mm
Min. thrust (under pressure) for rated thermal input	12 Pa
Fuel gas temperature	232 °C
Volume of fuel gas	6,5 g/s
CO emissions in fuel gas (at 13 % O ₂)	0,0811 %
Dust in the fuel gas (at 13 % O ₂)	18 mg/Nm ³
Volume of fuel per hour	2,47 kg/h
Fuel	wood (beech logs)
Weight	200 kg



LIST OF SPARE PARTS

Glass



670 x 468 mm
670 x 468 mm

Carcon stones

1. Front bottom
2. Back bottom
3. Right side
4. Left side
5. Carcon blend

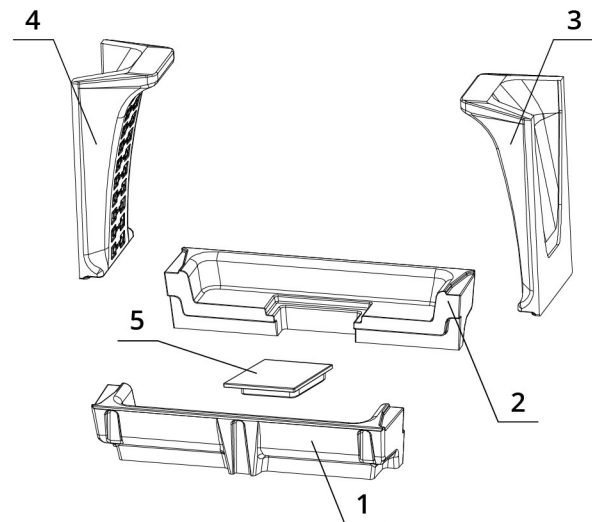

BEF DOUBLE FEEL V 7

BImSchV
Stufe 2

15a
B-VG

ČSN EN
13229

eco
design

www.befhome.com

TECHNICAL DRAWING

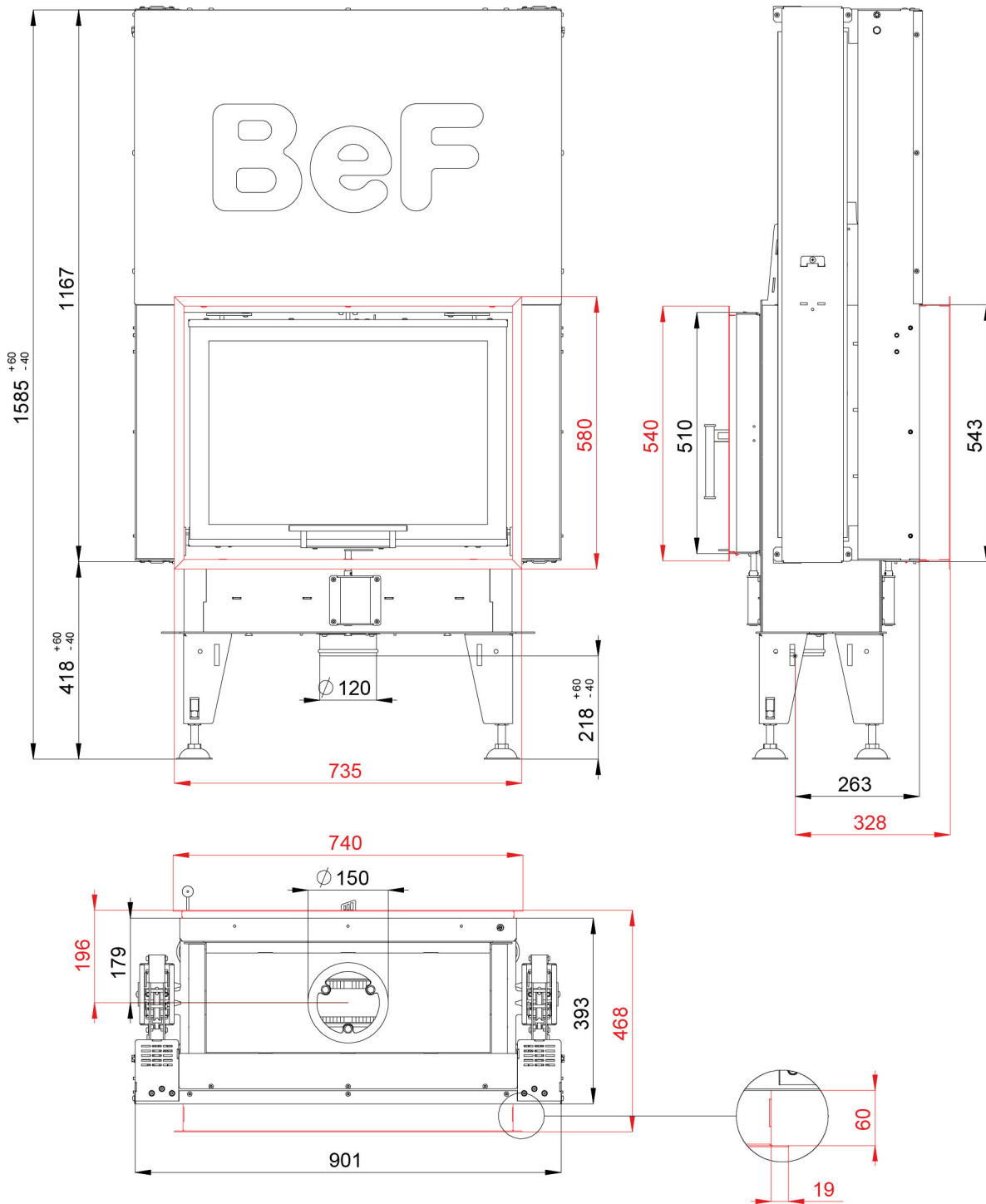

BEF DOUBLE FEEL V 7

BlmSchV
Stufe 2

15a
B-VG

ČSN EN
13229

eco
design