

## TECHNICAL DATA

Nominal heat output	6 kW
Efficiency	82 %
Smoke flue diameter	150 mm
Min. feed pressure at nominal heat output	12 Pa
Flue-gas temperature	262 °C
Volume flow of combustion products	4,6 g/s
CO emission in burnt gas (in relation to 13 % O <sub>2</sub> )	0,0873 %
Dust in flue - gas (in relation to 13 % O <sub>2</sub> )	19 mg/Nm <sup>3</sup>
Fuel consumption per hour	1,85 kg/h
Fuel	wood (beech logs)
Weight	147 kg



## LIST OF SPARE PARTS

### Glass

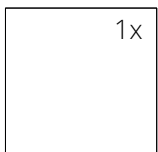

570 x 468 mm

### Set of carcon firebox lining

1. Front bottom
2. Back bottom
3. Back
4. Right side
5. Left side
6. Deflector
7. Cast iron grate
8. Ashtray

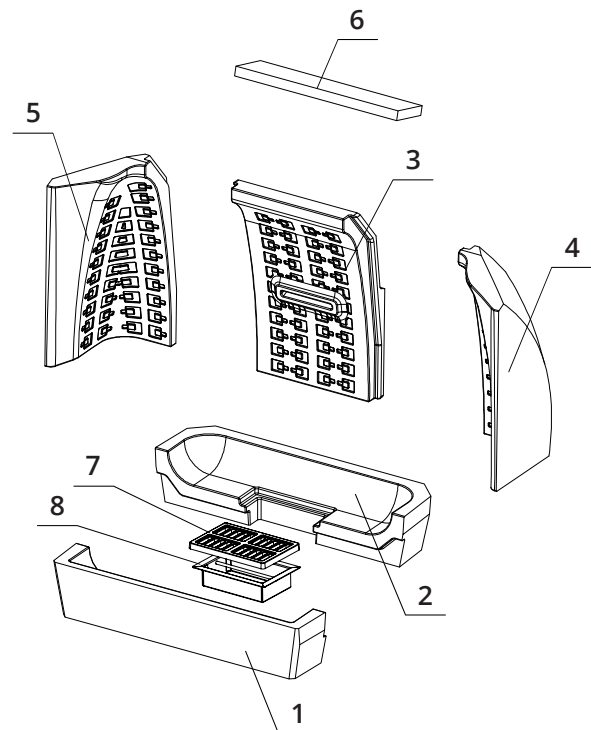

# BEF THERM 6

BlmSchV  
Stufe 2

15a  
B - VG

ČSN EN  
13229

## TECHNICAL DRAWING

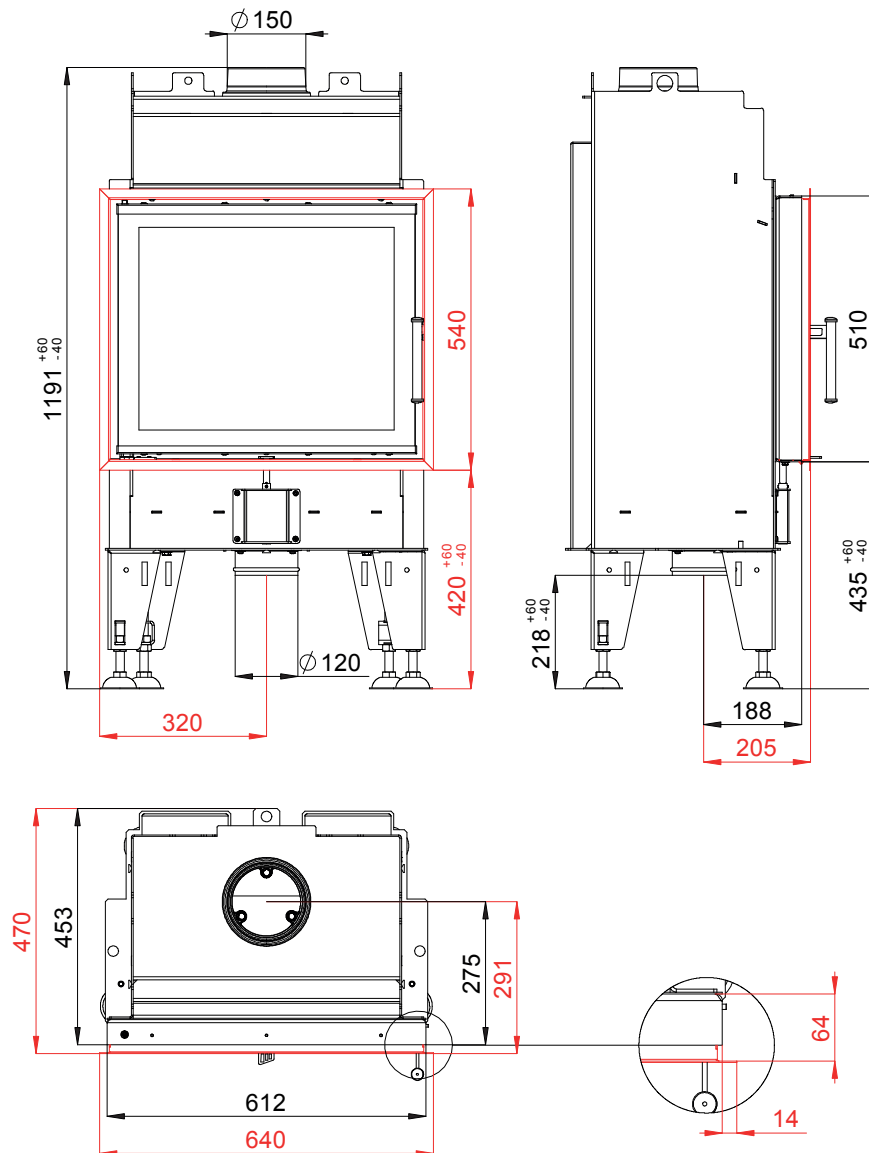

# BEF THERM 6

BlmSchV Stufe 2	15a B-VG	ČSN EN 13229
--------------------	-------------	-----------------

[www.befhome.com](http://www.befhome.com)